

SPECIFICATION

ITEM NO.: TS-3W1-W-MR16-S



LED SPOT LIGHT

EDITED BY	REVISED BY	CONFIRMED BY	APPROVED BY

LED Spotlight

A. PHOTO AND DIMENSION (MM)

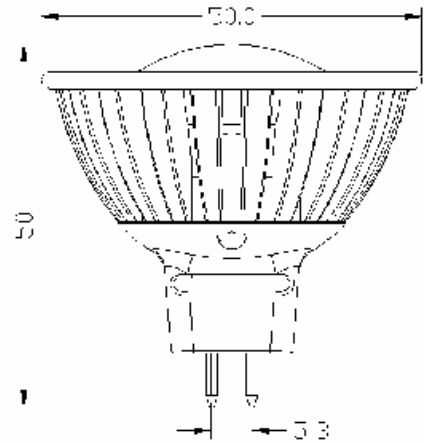





White base and black base optional.

B. PARAMETERS

Item No.	TS-3W1-W-MR16-S
LED source	CREE XR-E LED 
LED Qty	1 PCS
Color	White / Warm White
Luminous Flux	145 LM (White) / 115LM (Warm White)
Use environment	- 15 to 40°C
Working Temperature	50 to 68°C
Work voltage	AC 12V
Power consumption	3.0 -3.2 W
Beam Angle	50 / 80 / 120 Degree
Life span	50,000 Hours
Package	Net weight 83g/PC, 100 PCS/Carton

- White: 5700~6200K Warm White: 2800~3300K
-  Cree is a registered trademark of Cree, Inc

C. USE MANUAL

-  Please read this specification first to make sure the condition is suitable for use
-  Please shut off the switch before connect this products with power.
-  Please don't look at the light source directly when it's on
-  Recommend indoor use only