

# SPECIFICATION

ITEM NO.: TS-1W3-W-MR16-S



# LED SPOT LIGHT

EDITED BY	REVISED BY	CONFIRMED BY	APPROVED BY

## LED Spotlight

### A. PHOTO AND DIMENSION (MM)

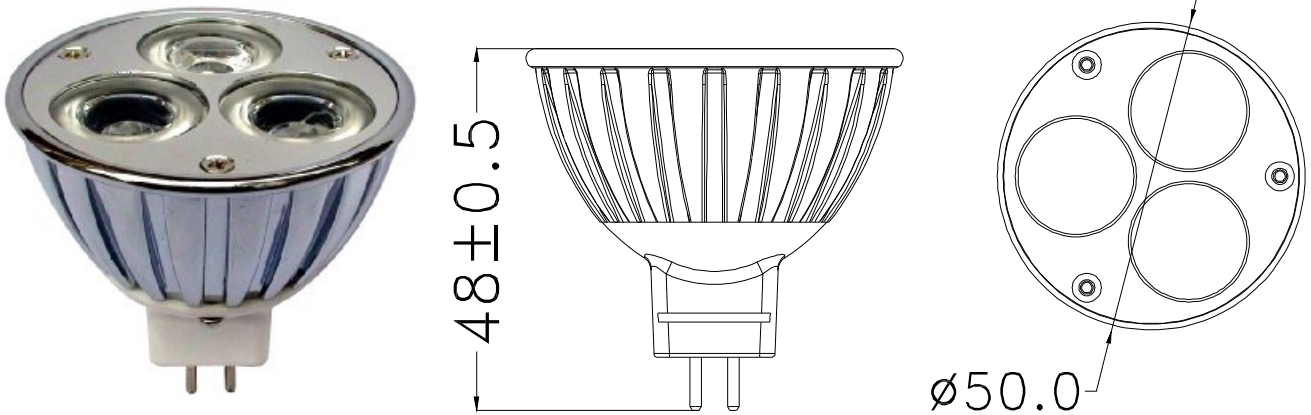





### B. PARAMETERS

Item No.	TS-1W3-W-MR16-S
LED source	CREE XR-E LED 
LED Qty	3 PCS
Color	White / Warm White
Luminous Flux	230 LM (White) / 180LM (Warm White)
Use environment	- 15 to 40℃
Working Temperature	50 to 68℃
Work voltage	AC 12V
Power consumption	3.0 -3.2 W
Beam Angle	30 / 45 / 60 Degree
Life span	50,000 Hours
Package	Net weight 83g/PC, 100 PCS/Carton

- a. White: 5700~6200K Warm White: 2800~3300K
- b.  Cree is a registered trademark of Cree, Inc

### C. USE MANUAL

-  Please read this specification first to make sure the condition is suitable for use
-  Please shut off the switch before connect this products with power.
-  Please don't look at the light source directly when it's on
-  Recommend indoor use only